

# “Off-peak” contactors 25 A with handle

Cat. N°(s) : 4 125 00 / 01 / 02 et 927 01 / 54



CONTENTS	PAGES
1. Description, use .....	1
2. Range.....	1
3. Overall dimensions .....	1
4. Preparation - Connection.....	1
5. General characteristics .....	3
6. Auxiliairies .....	6
7. Conformities and approvals .....	7

## 1. DESCRIPTION - USE

Symbol :

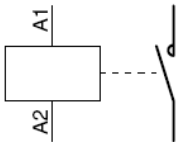

Technology :

. Electromagnetic contactor (monostable relay) with automatic return forced operation

Use :

. remote control of a load by the mean of a switch. This contactor is fitted with a handle enabling the stop or the forced march in automatic mode when an electrical control appears.  
. Generally use to supply a load( i.e electric water heater storage)

## 2. RANGE

Rated thermal current :

. I<sub>th</sub> = 25 A

Types of contacts :

. « NO », normally open contact

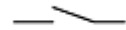

. Mixed contacts « NO+NC »

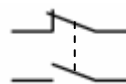

Poles :

. Double pole in 1 module (17,8 mm)  
- 2 « NO »  
- « NO » + « NC »  
. Three pole in 2 modules (35,6 mm)  
- 3 « NO »

## 2. RANGE (continued)

Rated voltage (power contacts) :

. Un = 250 V / 400 V ~

Rated control voltage :

. Uc = 230 V ~

Rated frequency, power and control :

. 50 / 60 Hz

## 3. OVERALL DIMENSIONS

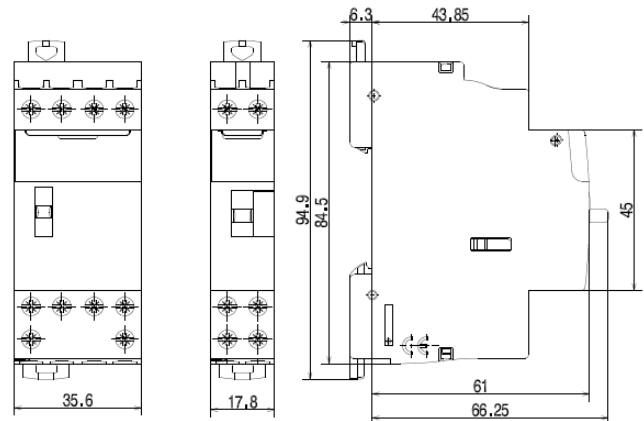

## 4. PREPARATION - CONNECTION

Installation software :

. XL PRO

Operational positions :

. Vertical, horizontal, flat (all positions)

Fixing :

. On symetrical rail EN 50-055 or DIN 35 by the mean of two plastic clamps.

# “Off-peak” contactors 25 A with handle

Cat. N°(s) : 4 125 00 / 01 / 02 et 927 01 / 54

## 4. PREPARATION – CONNECTION (continued)

### Recommended tools :

- . For terminal screws : screwdriver, insulated or not, Pozidriv n°1 or plate (4mm wide).
- . For fixing : Pozidriv n°1 or plate (5.5 mm max) screwdriver

### Position in a row :

. Due to the location of the terminals and the profile of the device, single phase and three phase prong busbars can go through the contactor without disturbing access to contactors top terminals. Whatever the place of the contactor in the row, M.C.B.'s installed on the same rail can be supplied by a prong busbar topside

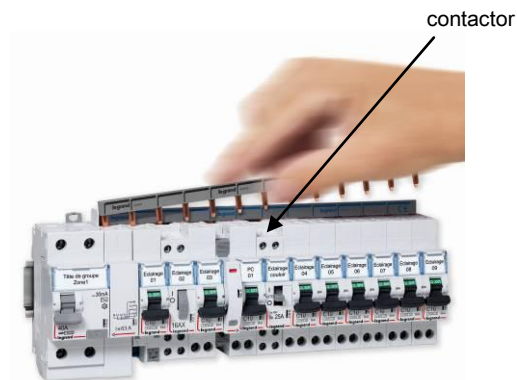

### Examples of wiring diagrams :

- . Contactor « NO + NC »

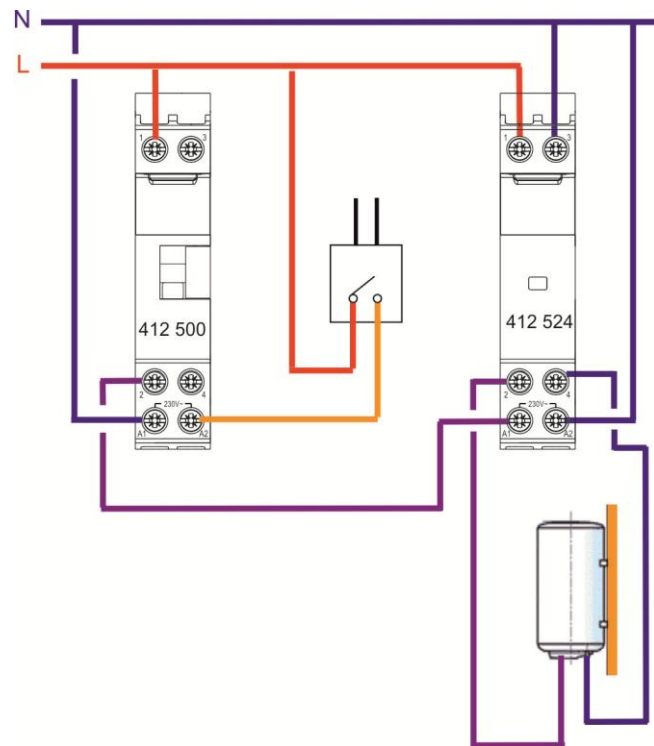

## 4. PREPARATION - CONNECTION (continued)

- . Contactor « 2 NO »

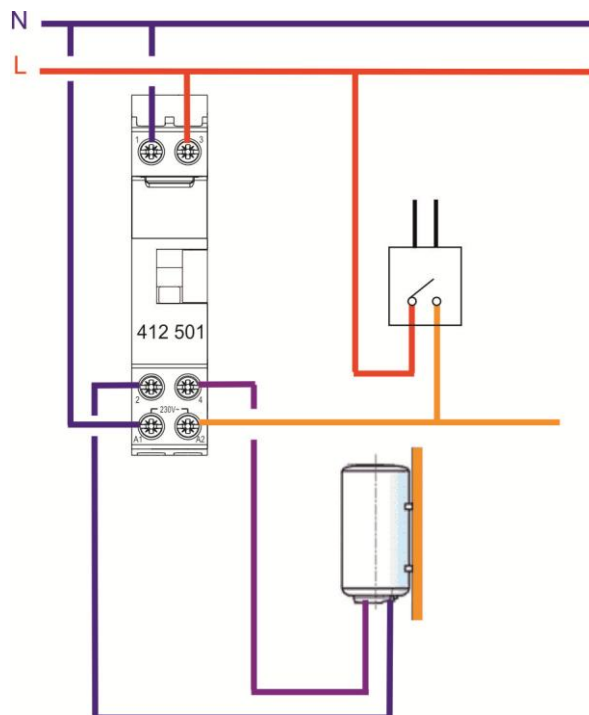

- . Contactor « 2 NO »

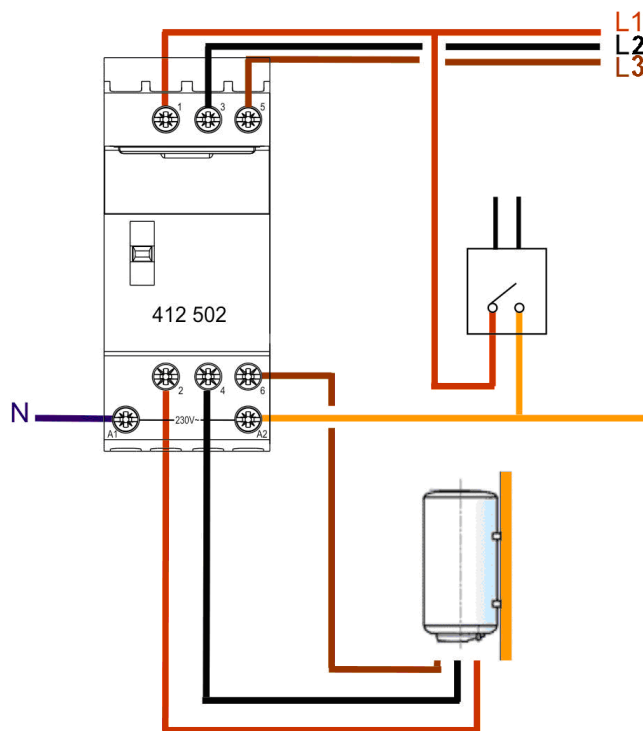

## 25 A with handle

### 4. PREPARATION - CONNECTION *(continued)*

#### Connection :

- . Control and power screw terminals :
  - Type of terminal : cage terminals
  - Terminal depth : 12 mm
  - Terminal capacity (h x w) : 4.7 x 4.7 mm
  - Copper cables

Rigid : 1 x (0.75 to 4 mm<sup>2</sup> recommended, 6 mm<sup>2</sup> max)  
or 2 x (0.75 to 2.5 mm<sup>2</sup>)

Flexible without ferrule : 1 x (0.75 to 4 mm<sup>2</sup> recommended,  
6 mm<sup>2</sup> max) or 2 x (0.75 to 2.5 mm<sup>2</sup>)

Flexible with single ferrule : 1 x (0.75 to 4 mm<sup>2</sup> recommended,  
6 mm<sup>2</sup> max)

Flexible with double ferrule : 1 x (0.75 to 4 mm<sup>2</sup>)

- Screw head type: mixed, Posidriv n° 1 and slotted 4mm
- Type of screw : M3,5
- Tightening torque : mini = 0.5 Nm / max = 1.2 Nm /  
recommended : 0.8 Nm

#### Length of control lines (230V) :

With 1.5 mm<sup>2</sup> copper wire :

- . 230 V contactor : 250 m (1 module contactor ) or 400 m (2 module contactor) whatever the wire cross-section.

#### Protection degree :

- . Terminal ingress protection : IP2x (device connected)
- . Front face ingress protection : IP3XD
- . Classe II, front face behind a cabinet faceplate
- . Protection against mechanical shocks : IK04

#### Resistance to tremors :

- . No change of contact state during the “resistance to tremors” test in accordance with EN 60898 standard

#### Manual actuation :

- . By remote control (switch).
- . By ergonomic 3 position (I, auto, O) handle :
  - Position « I » : permanent forced control ON
  - Position « O » : permanent forced control OFF
  - Position « auto » : electric control by switch
- . Handle automatically switches from position « I » (ON) to position « auto » when control circuit is under voltage (i.e. “off-peak” signal by power supplier)

#### Display of contacts state :

- . By orange indicator when control is “ON” (by electrical remote control or by the handle)

#### Labelling :

- . Circuit may be labelled by the mean of the label holder on the front face of the latching relay

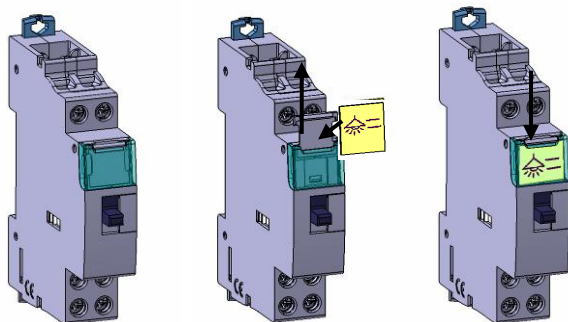

### 5. GENERAL CHARACTERISTICS

#### Marking :

By permanent ink pad printing

. Front face :

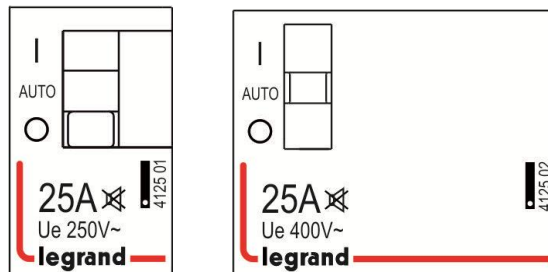

. Terminals :

1 to 6 : supply and load / A1 et A2 : control

Upper terminals



Lower terminals

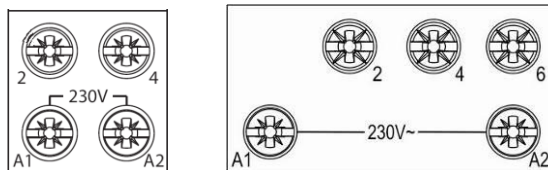

By laser marking

. Top face (certification logos, electric diagram)

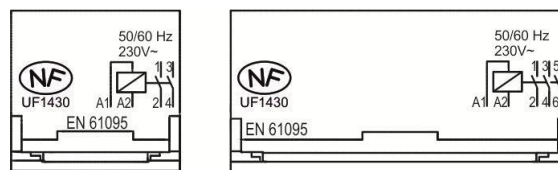

#### Isolation :

- . > 3 mm in compliance with EN 61095 standard

#### Isolation rated voltage (Ui) :

- . Double pole : 250 V~
- . Four pole : 400 V~

#### Pollution degree :

- . 2 according to EN 61095 standard

#### Isolation voltage between control and load :

- . 4 000 V.

#### Rated impulse withstand voltage (Uimp) :

- . 4 kV

## 25 A with handle

### 5. GENERAL CHARACTERISTICS (continued)

#### Withstand to electromagnetic disturbances (EMC) :

. Schock wave 1,2 / 50 µs : class 4 (2 kV between lines, 4 kV between line and earth)

#### Influence of altitude :

. no effect up to 2 000 m

#### Rated frequency :

. 50 / 60 Hz

#### Rated current for each category of use (Ie) :

. AC7a or AC1 (heating) : Ie = 25 A  
 . AC7b or AC3 (motor control) : Ie = 10 A (2.2 kW for 2NO contactor and 4 kW for 3 NO contactor)

#### Operation rated voltage (Ue) :

. Ue = 250 V ~ for double pole  
 . Ue = 400 V ~ for triple pole

#### Protection against short-circuits :

. Conditionnal short-circuit current Iq = 6 000 A according to EN 61095 standard  
 . Maximum thermal stress allowable : 16 000 A²s  
 . To protect 25 A contactors against short-circuits in accordance with conditionnal current Iq = 6 000 A (EN 61095 standard), we recommend to use a rated current ≤ 25 A M.C.B. or gG fuse.

#### Control voltage (Uc) :

. Uc = 230 V~

#### Operation control voltage :

. from 0.85 to 1.1 Uc

#### Release control voltage :

. from 0.2 to 0.75 Uc

#### Control impulse time :

. 100 ms mini

#### Rated duty :

. Intermittent duty : 600 operating cycles per hour according to EN 61095 standard (class 600)

#### Force by handle operation :

. 1000 g for closing and opening operation

#### Operation under 400 Hz :

. not possible

#### Noise :

. ≤ 35 dB at 1 cm

#### Endurance :

In number of operating cycles (ON + OFF)  
 . Control by handle : 500 operating cycles  
 . Electrical control :  
 - 1 000 000 operating cycles with no load  
 - 100 000 operating cycles at Ie AC-7a in accordance with EN 61095 (same at Ie AC1)  
 150 000 operating cycles at Ie AC-7b in accordance with EN 61095 (same at Ie AC3)

### 5. GENERAL CHARACTERISTICS (continued)

#### Use with Direct Current (DC) :

. Control : do not operate with DC  
 . Power circuit : NO and NC contacts may be used to control loads supplied with DC in accordance with the table of max current below

Ue	DC 1 (resistiv load)			DC 3 (motors)		
	number of poles in series			number of poles in series		
	1 p	2 p	3 p	1 p	2 p	3 p
8 V=	25 A	25 A	25 A	21.5 A	25 A	25 A
12 V=	25 A	25 A	25 A	20 A	25 A	25 A
24 V=	25 A	25 A	25 A	16 A	25 A	25 A
48 V=	21 A	25 A	25 A	8 A	18 A	25 A
110 V=	7 A	16 A	25 A	1.6 A	6.5 A	16 A

#### Control consumption :

Type of contact	Control voltage	Current in mA (at Un)	
		sustain	inrush
O+F	230 V~	20	90
2F		12	60
3F		20	200

Type of contact	Control voltage	Power in W (at Un)
		sustain
O+F	230 V~	1.2
2F		0.8
3F		1.3

#### Average dissipated power per contact at 230V :

. 1,8 W per contact of 25 A contactor

#### Annual energy consumption of contactors :

. Loads supplied in 230/400V 50Hz network  
 . Global energy consumption, control + power contacts, with an « average » use.

Type of contact	Control voltage	in kWh (at Un)
O+F	230 V~	3.4
2F		3.1
3F		4.9

# “Off-peak” contactors

## 25 A with handle

Cat. N°(s) : 4 125 00 / 01 / 02 et 927 01 / 54

### 5. GENERAL CHARACTERISTICS (continued)

#### Operating temperatures :

- . A standard contactor is set to operate at its rated current (16 A or 25 A) in an ambient temperature of + 30°C
- . In order to limitate overheating, we recommend to use a spacing element (cat. n° 044 40)
  - Every 2 contactors if the ambient temperature  $\leq 40^\circ\text{C}$
  - Every contactors if the ambient temperature  $> 40^\circ\text{C}$
- . Depending on ambient temperature, use deratings below :
  - from - 25°C to + 40°C, no derating
  - from + 40°C to + 60°C derating as in table below

Contactor rated current	40°C	50°C	60°C
$I_e = 25 \text{ A}$	25 A	22 A	20 A

#### Storage temperature :

- . from - 40°C up to + 70°C

#### Moulded case material :

- . Polyamid

#### Characteristics of the plastic material :

- . Resistance to glow wire test during 30 s according to IEC 60669-2-2 (§24.1) :
  - Handle : 650°C / Other components : 850°C

#### Weight :

- . 0.120 kg per single pole / double pole device
- . 0.230 kg per triple pole / four pole device

#### Packaged volume :

- . 0.2 dm<sup>3</sup> for double pole individually packaged units
- . 1.6 dm<sup>3</sup> for double pole units packaged per 10
- . 0.4 dm<sup>3</sup> for triple pole individually packaged units

#### Contactors choice table :

For a life time of 10 years with 200 days of annual use

- . Heating

Maximum power according to the number of operations per day (kW)					
Number of operations per day	$\leq 50$	75	100	250	500
single phase heating 230 V~	5,6	4,4	3,7	2,5	1,25
three phase heating 400 V~	16	13,7	11,3	5	3,7

- . Motors (AC-7b)

single phase motor 230 V~	2,3 kW
three phase motor 400 V~	4 kW

### 5. GENERAL CHARACTERISTICS (continued)

- . Lighting

Maximum number of lamps per contact of the contactor in 230 V~ single phase network and 400 V~ three phase and neutral network.

- . In 230 V~ three phase network with no neutral, values of the tables below must be divided by  $\sqrt{3}$

- Incandescent lamps

Tungsten filament 230 V~ and low voltage halogen				
Unit power	40 W	60 W	75 W	100 W
25 A	60	48	38	30

Tungsten filament 230 V~ and low voltage halogen (continued)				
Unit power	150 W	200 W	500 W	1000 W
25 A	20	15	6	3

Very Low Voltage halogen lamps with ferromagnetic ballast						
Unit power	20 W	35 W	50 W	75 W	100 W	150 W
25 A	52	30	24	16	12	8

Very Low Voltage halogen lamps with electronic ballast						
Unit power	20 W	35 W	50 W	75 W	100 W	150 W
25 A	80	50	40	26	20	13

- Fluorescent lamps with ferromagnetic ballast

Single parallel compensated					
Unit power	18 W	20 W	36 W	58 W	115 W
25 A	33	30	25	17	9

Twin serial compensated					
Unit power	2 x 20 W	2 x 36 W	2 x 40 W	2 x 58 W	2 x 140
25 A	45	38	35	24	10

Four serial compensated	
Unit power	4 x 18 W
25 A	24

Compact with integrated starter				
Unit power	7 W	10 W	18 W	26 W
25 A	60	50	42	28

- Fluorescent lamps with electronic ballast

Single				
Unit power	18 W	30 W	36 W	58 W
25 A	110	68	58	36

# “Off-peak” contactors

## 25 A with handle

Cat. N°(s) : 4 125 00 / 01 / 02 et 927 01 / 54

### 5. GENERAL CHARACTERISTICS *(continued)*

- Fluorescent lamps with electronic ballast

Twin			
Unit power	2 x 18 W	2 x 36 W	2 x 58 W
25 A	56	30	19

Triple serial compensated		
Unit power	3 x 14 W	3 x 18 W
25 A	46	38

Four serial compensated		
Unit power	4 x 14 W	4 x 18 W
25 A	37	28

With integrated electronic supply					
Unit power	7 W	11 W	15 W	20 W	23 W
25 A	200	125	90	70	60

- Discharge lamps with compensator

Metal halide						
Unit power	35 W	70 W	100 W	150 W	250 W	400 W
25 A	15	9	7	5	3	2

Low pressure sodium						
Unit power	18 W	35 W	55 W	90 W	135 W	180 W
25 A	20	10	7	5	3	3

High pressure sodium					
Unit power	70 W	150 W	250 W	400 W	1000 W
25 A	10	9	6	4	2

High pressure mercury					
Unit power	50 W	80 W	125 W	250 W	400 W
25 A	15	10	8	4	3

Mixed high pressure				
Unit power	100 W	160 W	250 W	400 W
25 A	11	7	5	3

### 6. AUXILIARIES

#### Auxiliaires :

. Signalling change-over switch NO+NC auxiliaries cat. n° 4 124 29 and 4 124 30.

- Cat n° 4 124 29 fits double pole contactors, one module wide
- Cat n° 4 124 30 fits triple pole contactors, two module wide.

#### Association of the auxiliaries :

. Auxiliaries are fitted on left hand side of contactor

. Used to signal the position status of the contacts of the product to which it is associated

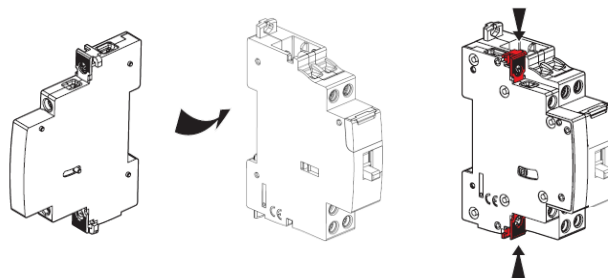

- . Maximum of 2 change-over switch auxiliaries per contactor
- cat. n° 4 124 29

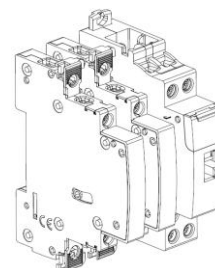

- cat. n° 4 124 30

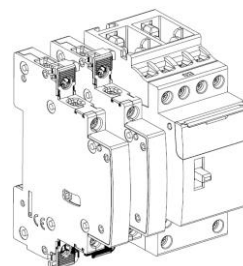

**25 A with handle**

**7. CONFORMITIES AND APPROVALS**

**Compliance :**

- . NF EN 61095 / IEC 61095
- . NF EN 60947-4-1 : AC1 et AC3

**Classification in accordance with Appendix Q** (standard IEC/EN 60947-1)

- . Category F

Inter alia: temperature test range -25°C/+70°C, vibration test 2 Hz to 13.2 Hz with ±1 mm movement, 13.2 Hz to 100 Hz acceleration ±0.7 g, salt spray in accordance with IEC 60068-2-52

**Respect for the environment – Compliance with European Union Directives:**

- . Compliance with Directive 2002/95/EC of 27/01/03 known as “RoHS” which provides for a restriction on the use of dangerous substances such as lead, mercury, cadmium, hexavalent chromium and polybrominated biphenyl (PBB) and polybrominated diphenyl ether (PBDE) brominated flame retardants from 1<sup>st</sup> July 2006
- . Compliance with the Directive 91/338/EEC of 18/06/91 and decree 94-647 of 27/07/04

**Plastic materials:**

- . Zero halogen plastic materials.
- . Labelling of parts compliant with ISO 11469 and ISO 1043.

**Packaging:**

- . Design and manufacture of packaging compliant with decree 98-638 of 20/07/98 and Directive 94/62/EC

**Certificates :**

- . NF (France)