



INPUT: 220-240V ~ 50/60Hz CLASS I 	
LAMP-HOUSE: LED-1W(Max.)	
MATERIAL: ALUMINIUM	
IP54  	

INSTALLATION INSTRUCTION

- Before installing, make sure the power supply is switched off.
- Follow the steps as the figure for installation or replacement of bulb
Step.
 - after holing, pull out the wires.
 - fix the mounting bracket onto the wall with screws.
 - connect the wires to the terminal block.
 - fix the fixture to the mounting bracket with screws.
- After finishing every step, tighten the screws, have the fixture fixed, and then connect the power supply.

CLEANING INSTRUCTION

- Before cleaning, ensure that the power supply is switched off.
- Use only a soft cloth to clean the lamp, dampened with mild cleanser if needed for resistant dirt.
- Warning: do not use alcohol or other solvents.

CAUTION:

In case of any doubt, please contact the qualified electrician.

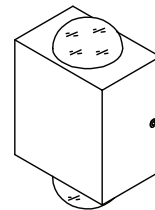
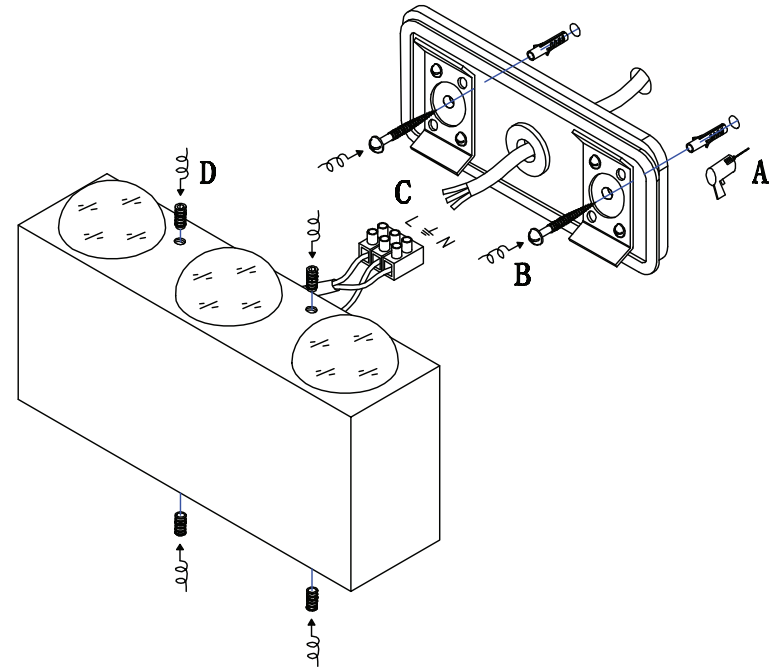
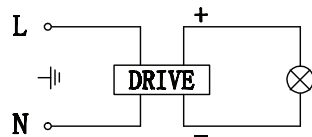

DL18361/21WW

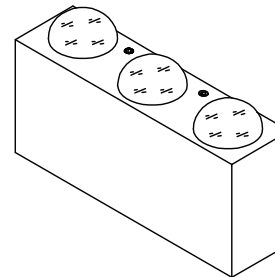
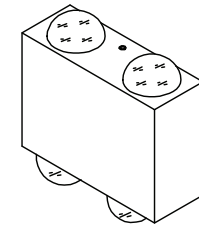

DL18361/13WW

